

Pompe ad ingranaggi

Gruppo 4



Informazioni Generale

Il Gruppo 4 Danfoss è una gamma di pompe a ingranaggi a cilindrata fissa ad alte prestazioni. Costruiti con un corpo in estruso di alluminio ad alta resistenza con coperchio e flangia in alluminio, tutte le pompe sono bilanciate per un'efficienza eccezionale.

Caratteristiche Principali Gruppo 4

- Ampia gamma di cilindrata da 60 a 200 cm³ / giro [da 3,66 a 12,2 pollici³ / giro]
- Pressione continua fino a 220 bar [3191 psi]
- Velocità fino a 3000 min⁻¹ (rpm)
- Flange di montaggio standard SAE ed europee
- Ingranaggi in acciaio cementato di alta qualità
- Configurazioni multiple della pompa in combinazione con altre cilindrata dei gruppi SNP1NN, SNP2NN e SNP3NN

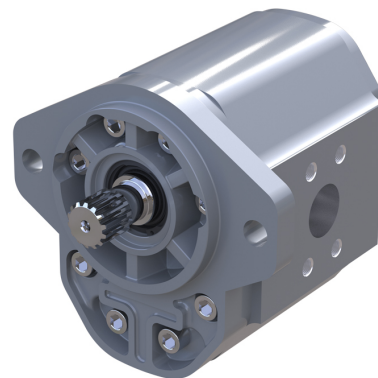

Caratteristiche Tecniche TAP4NN

TAP4NN pump model		Frame size						
		60	85	106	130	148	180	200
Displacement	cm ³ /rev [in ³ /rev]	58.0 [3.54]	83.3 [5.08]	103.4 [6.31]	126.1 [7.69]	143.8 [8.77]	174.1 [10.62]	194.3 [11.86]
Peak pressure	bar [psi]	230 [3335]	230 [3335]	230 [3335]	230 [3335]	220 [3190]	180 [2610]	160 [2320]
Rated pressure		220 [3190]	220 [3190]	220 [3190]	220 [3190]	210 [3045]	170 [2465]	150 [2175]
Minimum speed	min ⁻¹ (rpm)	650	650	600	550	500	500	480
Maximum speed		3000	3000	2500	2500'	2400	2400	2400

Configurazioni Alberi, Flange e porte

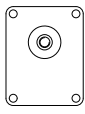
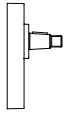
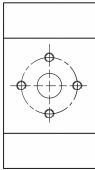
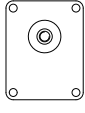
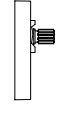
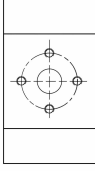
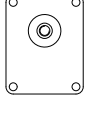
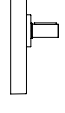
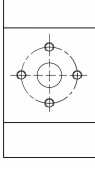
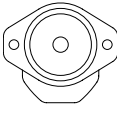
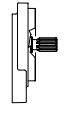
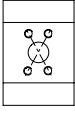
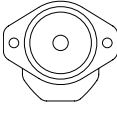
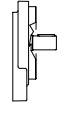
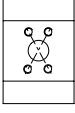
Motor	Code	Flange		Shaft		Port	
TAP4NN	01BA	pilot Ø 63.5 mm [2.5 in] European 01, 4- bolt		1:8 tapered		European flanged port + pattern	
TAP4NN	01DA	pilot Ø 63.5 mm [2.5 in] European 01, 4- bolt		Spline DIN 5482 B35x31xL44		European flanged port + pattern	
TAP4NN	01FA	pilot Ø 63.5 mm [2.5 in] European 01, 4- bolt		Parallel Ø30-Key 8x7xL50		European flanged port + pattern	
TAP4NN	02RA	pilot Ø 127 mm [5.0 in] SAE C, 2- bolt		Splined-SAE J498-14T		Vertical four bolt flanged port	
TAP4NN	02GA	pilot Ø 127 mm [5.0 in] SAE C, 2- bolt		Parallel Ø31,75- Key 7,962x7x36		Vertical four bolt flanged port	

Attacchi

F7	1-1/4 GAS	Threaded GAS (BSPP)
F8	1-1/2 GAS	
F9	1-3/4 GAS	
GE	32x62x7/16-14UNC	Flanged port with the holes in + pattern UN thread
GF	38x72,5x1/2-13UNC	
GK	48x72,5x1/2-13UNC	

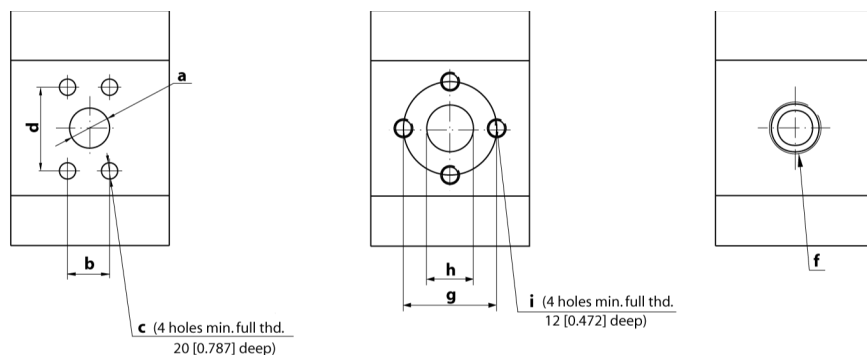

Dimensioni

TAP4NN - 01FA, 01DA, and 01BA

mm
[in]

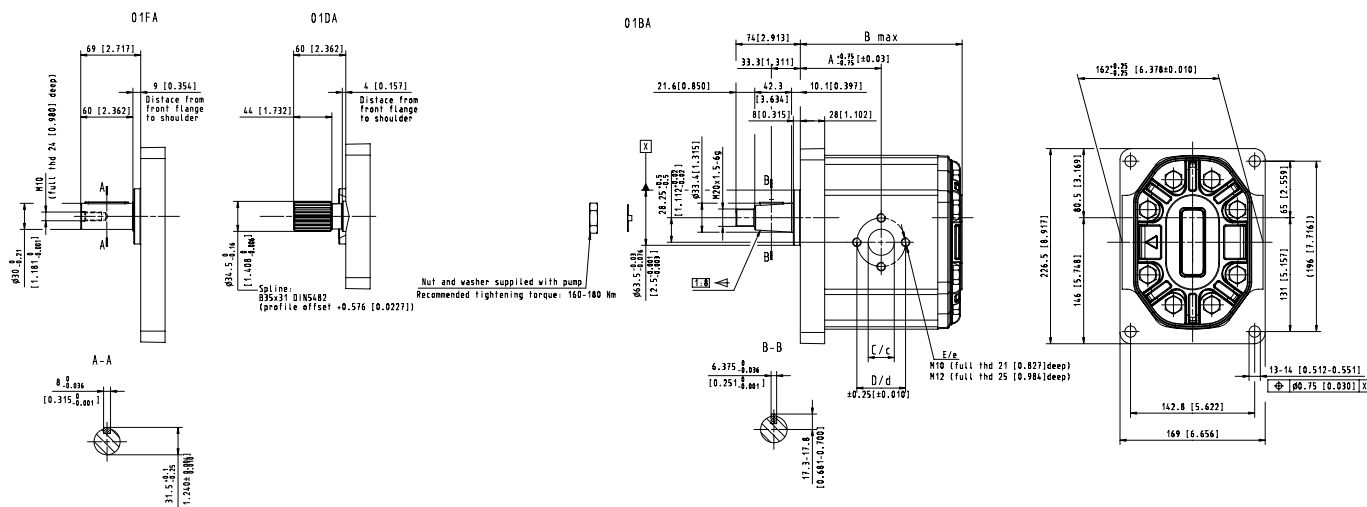

TAP4NN – 01FA, 01DA, 01BA dimensioni

Frame size		060	085	106	130	148	180	200
Dimension	A	84 [3.3]	89 [3.5]	93 [3.66]	97.5 [3.84]	101 [3.98]	107 [4.21]	111 [4.37]
	B	168 [6.61]	178 [7.0]	186 [7.32]	195 [7.68]	202 [7.95]	214 [8.42]	222 [8.74]
Inlet	C	36 [1.42]			45 [1.77]		56 [2.2]	
	D	62 [2.44]			72.5 [2.85]		92 [3.62]	
	E	M10			M12		M12	
Outlet	c	30 [1.18]			36 [1.42]		45 [1.77]	
	d	56 [2.2]			62 [2.44]		72.5 [2.85]	
	e	M10			M10		M12	

